

# Property protection.

Mesh panels for secure storage solutions.

# Contents

- 03.** Property protection
- 04.** Our services
- 06.** Protect your property
- 08.** Unique solutions
- 10.** Troax Classic
- 14.** Troax Medium
- 18.** Troax Safe
- 22.** Troax Self storage
- 26.** True colours/Smart accessories
- 27.** Troax worldwide

Troax is a global developer and manufacturer of steel mesh panels for machine guarding, warehouse partitioning and property protection. This brochure presents our solutions for the market segment Property protection. Our business concept is to develop innovative steel mesh panel solutions to protect people, property and processes. Our lightweight but strong mesh panels can be combined into unique solutions and are built to withstand the toughest tests and environments. Read more about our systems at [www.troax.com](http://www.troax.com)

**TROAX**

# Property protection.

For more than 60 years we have been developing innovative steel mesh panel solutions for machine guarding, warehouse partitioning, and property protection. Today we are the market leader, and our products can be found all over the world – protecting people, property and processes.

# Troax Total.

Within the segment Property Protection, Troax offers a complete service throughout the entire process, which is called Troax Total.

Our systems are adapted and designed to suit your specific needs, with everything intricately planned down to the smallest detail. Our systems can be built to suit all kinds of application areas. Troax Total is a total solution within property protection, where every solution is flexible to suit your needs and requirements. With Troax Total, you will get a solution that is:

- **Assembled**
- **Guaranteed**
- **Safe**
- **Fast**
- **Easy**





## TROAX IS THE ORIGINAL AND RELIABLE PARTNER FOR STORAGE SOLUTIONS.

- Guaranteed products and installations to meet the customer's specific demands.
- Extremely durable mesh panel solutions.
- Products of the highest quality and functionality.
- Easily combined systems, which makes the solutions flexible and efficient to meet the customer's expectations.
- Anti-theft test according to SSF.
- High capacity and fast deliveries.
- Local presence – both service and support.
- Troax is Your natural partner for storage solutions in new construction and renovation projects.



# Protect your property.

Troax offers a wide range of storage and property protection systems. Whatever your storage needs may be, Troax will create a solution that fits them.

Storage walls made from security mesh partitions have many advantages. Mesh panels provide good light and ventilation, as well as protection against damage and break-ins. Troax offers several mesh panel systems, including a wide range of doors and locks, with various levels of protection. Combined with our partition system Caelum, the mesh systems can be built to fit most properties and storage spaces, even those with sloping ceilings. We also provide storage solutions that are completely enclosed, and/or protected from public view. For immediate delivery, storage walls in our standard colour RAL 7037 are available at any time.



## 1 Garage

The system is based on panels and secures garages against break-ins and vandalism. Regardless of the level you choose – a standard or a premium design – you will get a secure garage system.

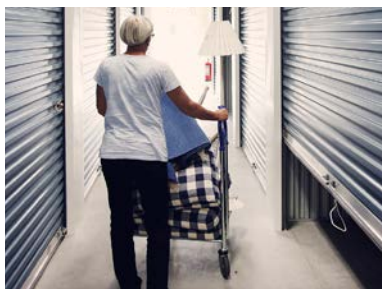
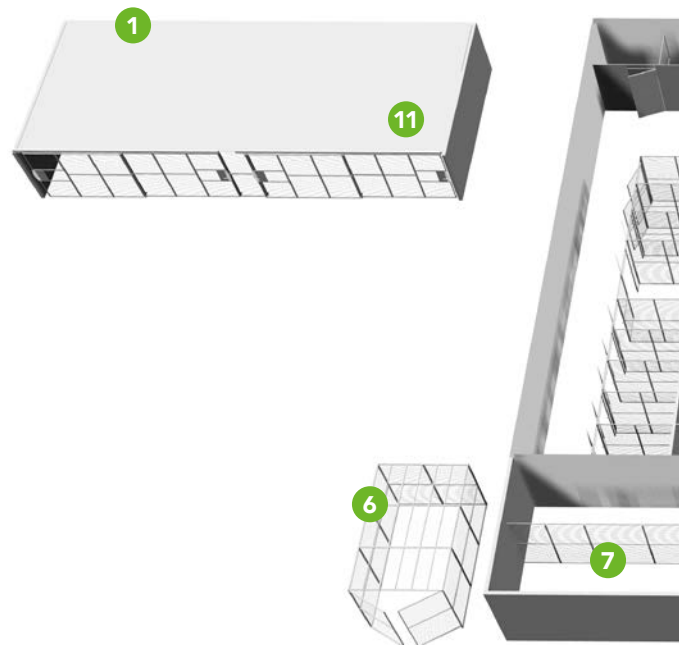

## 5 Self storage

Our roller doors and sheet metal partitions have been developed specifically for self storage facilities, and it is as simple to install as it is easy to use.



## 6 Troax Cage

Our boxes can be used both indoors and outdoors, as a permanent or temporary solution.

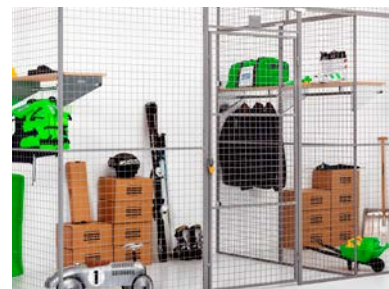

## 7 Troax Classic

This mesh panel fits areas with good external protection and little risk of damage. It can also be used as a partition wall in combination with other Troax systems.



## 8 Troax Medium

The medium panel is used in areas that demand good protection against uninvited guests. In combination with approved locks, it significantly reduces the risk of break-ins.



Our modular mesh gates are designed to resist break-ins, regardless of the security standard or customised solution. They are secure and flexible.



### 2 Steel panels

UR SP is a secure, durable, and easy-to-assemble storage solution, which is ideal for situations that require privacy protection. UR SP is easily combined with our other types of mesh storage panels.



### 3 Loft space

Our flexible systems are easily adapted to most properties and spaces – even those with a more complicated layout, such as loft spaces with sloping ceilings.



### 4 Enclosure

Our Caelum wall system is flexible and can easily be adapted to locations that are difficult to access.

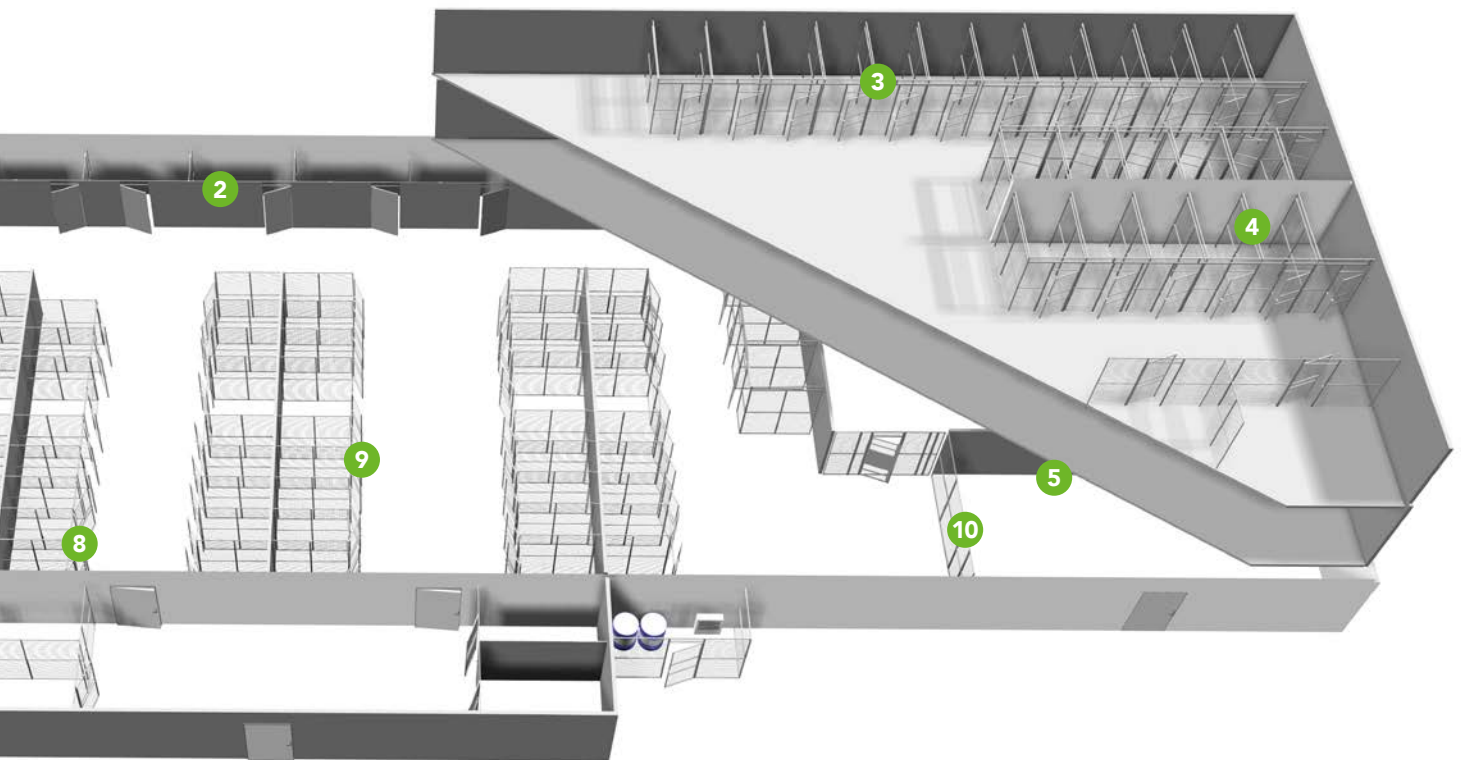

Troax Safe is used primarily in areas that require protection against break-ins. In combination with other storage solutions, it significantly reduces the risk of theft.



### 9 Troax Safe

This is our safest product. It is certified according to the Swedish Theft Prevention Association's standard for storage installations that protect against break-ins. The system is suitable for spaces that are particularly vulnerable to break-ins.



### 10 Doors

Our secure, thresholdless door systems in the Classic and Medium ranges make it easy to move property in and out of the storage space.



### 11 Bicycle storage

Troax offers the most secure protection for theft-prone properties such as bikes and pushchairs.

# Combine our systems for unique solutions.

Our three property protection systems can be combined in a number of ways to suit your safety and storage needs, which is an innovative way to give you an affordable and future-proof solution.

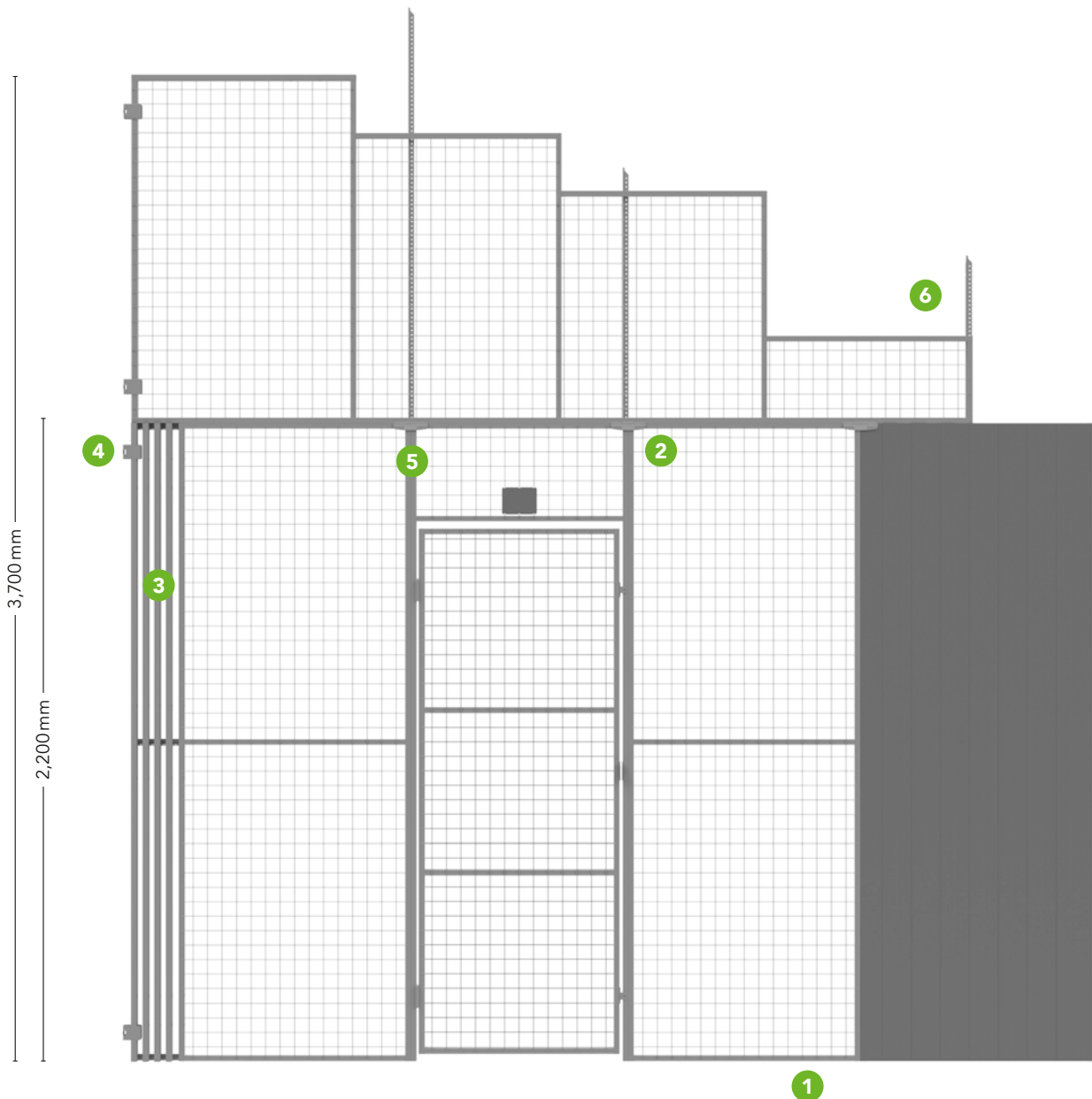





### 1 Floor support

The simple and unique floor support makes it easy to adapt the system to various conditions, such as an uneven floor.



### 2 Snapper

Snappers are used to fix panels together in order to make the partition walls safe and strong, which in turn makes the ceiling mounting extremely strong and durable.



### 3 Filler kit

The filler kit is used in combination with the filler pipe, which is secured into the smart profile, to fill gaps in the wall system.



### 4 Wall fixing

With our wall fixings, panels can be adjusted and secured to adjoining structures for a perfect fit.



### 5 Screws and fittings

Our systems are based on self-tapping screws in combination with a variety of different fittings to provide extremely strong and flexible fixings.



### 6 U-profile

Our U-profiles are used to conceal sharp edges where adaptations have been made.

Door (HxW) mm:	Door type
2,200x750	Classic, medium
2,200x900	Classic, medium, Safe, UR SP

Panel (HxW) mm:	Panel type
2,200x200	Classic, medium, Safe, UR SP
2,200x300	Classic, medium, Safe, UR SP
2,200x500	Classic, medium
2,200x700	Classic, medium, Safe, UR SP
2,200x800	Classic, medium, Safe, UR SP
2,200x1,000	Classic, medium, Safe, UR SP
2,200x1,200	Classic, medium, Safe, UR SP
2,200x1,500	Classic, medium, Safe

**Maximize Storage.**  
**Easy Installation.**  
**Maintenance-Free.**



# Troax Classic.

Troax Classic is an excellent choice of mesh partition for storage spaces in apartment buildings, cellars and attics that already have exterior protection or where there is a low risk of tampering. The mesh panels provide excellent visibility, as well as good lighting and ventilation conditions. In case of fire, mesh systems make for easy detection and extinction. Doors without thresholds facilitate the transfer of property in and out of the storage area.

**Economical.**

**Easy Installation.**

**In stock ready to ship.**

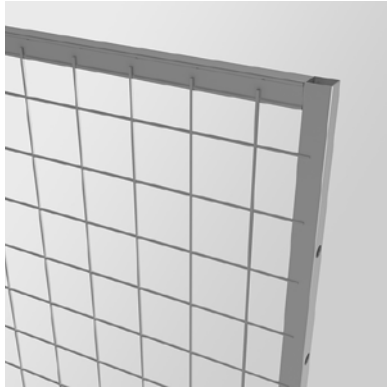

### Panel Classic UR 350

Forms the basis of the Classic system.

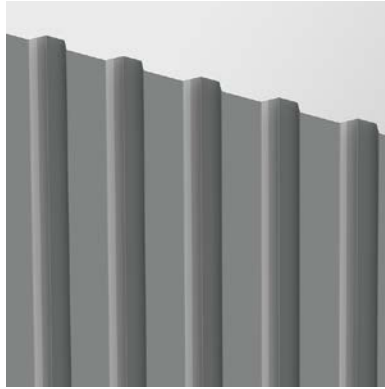

### Panel Classic P

The full cover option to Classic system.



### Strike plate

The classic door is supplied for use with padlocks.

#### Panel (H×W) mm:

Panel Classic	2,200×200
Panel Classic	2,200×300
Panel Classic	2,200×500
Panel Classic	2,200×700
Panel Classic	2,200×800
Panel Classic	2,200×1,000
Panel Classic	2,200×1,200
Panel Classic	2,200×1,500

#### Door with padlock fittings (H: 2,200 mm)

Door Classic P 750 H (opening H: 1,860 mm)
Door Classic P 750 V (opening H: 1,860 mm)
Door Classic P 900 H (opening H: 2,000 mm)
Door Classic P 900 V (opening H: 2,000 mm)

#### Component information

Frame:	19×19×1.0 mm
Wire:	2.5×2.5 mm
Mesh:	50×50 mm
Surface treatment:	Powder coating, Grey RAL 7037

Also available in galvanised finish and RAL colours.

The Troax Classic is an entry-level mesh panel, based on a welded tube construction of 19×19 mm. The mesh consists of pressure-welded wire gauges, each 2.5 mm, with the mesh equivalent to 50×50 mm.

#### Doors

#### Panels

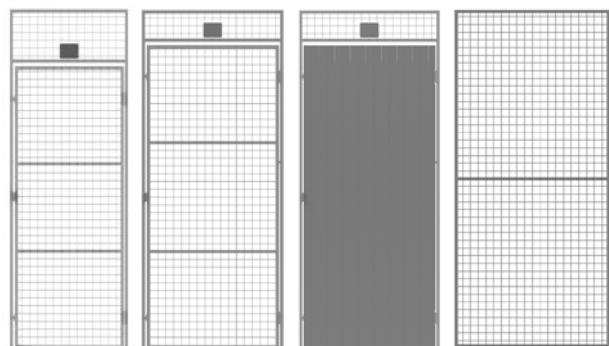



"Our panels are made of  
100% high-quality steel."

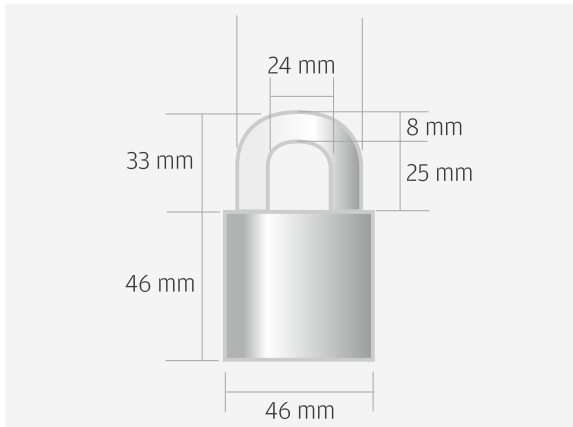

Recommended padlocks.



Thresholdless door systems.



Welded numbered plates as standard.

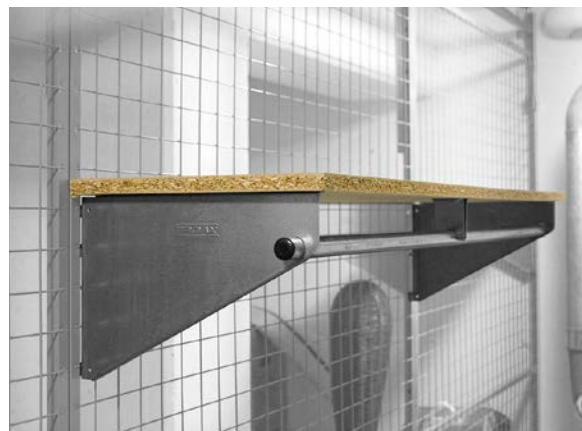

Flexible chipboard shelf with brackets.

## PANELS

If you need a mesh partition for a space with a low risk of break in, choose the UR 350 panel, which is the backbone of Troax Classic. This panel provides a light and airy storage environment. UR 350 can also be used as a partition wall between our other systems. The frame is constructed from 19×19 mm welded tubing. The mesh consists of press-welded 2.5 mm wire, and the mesh size is equivalent to 100×50 mm or 50×50 mm.

## DOORS

Our secure thresholdless door systems facilitate passage, particularly for people with physical disabilities. The UR 350

door has a frame made from 30×20 mm steel tubing and two specially designed cross tubes, making it stable and secure. The mesh size of 50×50 mm is almost impossible to force by hand. The doors are delivered preassembled and ready for mounting. Doors are available in heights from 2,200 mm and come in a range of colours, standard colour being grey.

## PROTECTION FROM VIEW

Type P consists of panels made of corrugated aluzinc sheeting, intended as alternative front panels. The sheet metal panels are compatible with the UR 350 and UX 450 mesh panels as partition walls or roofs.

## ACCESSORIES

Troax modules and accessories can be used to adapt the installation to almost any type of premises: narrow or wide, low or high ceilings, as well as sloping floors. Our system is based on our self-tapping screws, combined with a variety of different mountings to provide incredibly strong and versatile fixings. Our snappers are used to fix panels together safely and strongly; this also makes the ceiling mounting incredibly strong. The range of accessories also includes different shelving systems with brackets for versatile placement, as well as a special system for storing skis.



# Troax Medium.

Troax Medium is a mesh partition system for storage spaces in apartment buildings, cellars and attics where there needs to be a reasonable level of protection against uninvited guests. Combined with approved locks and reinforced front panels, it minimises the risk of break-ins. The mesh provides good visibility, which in turn creates a sense of security. The mesh panels allow light to penetrate and air to circulate. Fires can be quickly detected and extinguished from outside the storage space.

**Versatile.**

**Good visibility.**

**Maintenance-Free.**

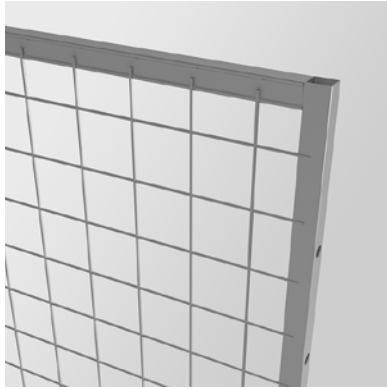

### Panel UX 450

Forms the basis of the Medium system.

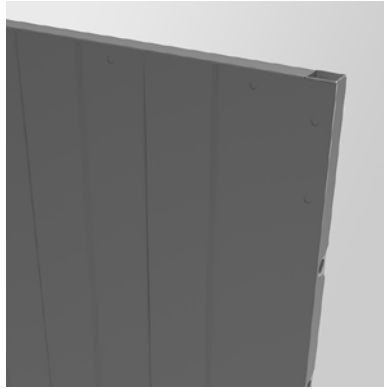

### UR SP

For a fully-covered solution to protect your privacy.



### Flexible chipboard shelf

With brackets.

#### Panel (H×W) mm:

Panel Medium	2,200×200
Panel Medium	2,200×300
Panel Medium	2,200×500
Panel Medium	2,200×700
Panel Medium	2,200×800
Panel Medium	2,200×1,000
Panel Medium	2,200×1,200
Panel Medium	2,200×1,500

#### Door with padlock fittings (H: 2,200 mm)

Door Medium P 750 H (opening H: 1,860 mm)
Door Medium P 750 V (opening H: 1,860 mm)
Door Medium P 900 H (opening H: 2,000 mm)
Door Medium P 900 V (opening H: 2,000 mm)

#### Door ready for EURO cylinder (H: 2,200 mm)

Door Medium EC 900 H (opening H: 2,000 mm)
Door Medium EC 900 V (opening H: 2,000 mm)

#### Door ready for ASSA cylinder (H: 2,200 mm)

Door Medium AC 900 H (opening H: 2,000 mm)
Door Medium AC 900 V (opening H: 2,000 mm)

#### Component information

Frame:	30×20×1.25 mm
Wire:	3.0×3.75 mm
Mesh:	50×50 mm
Surface treatment:	Powder coating, Grey RAL 7037

Also available in galvanised finish and RAL colours.

#### Doors

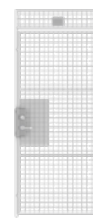
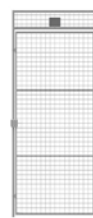

#### Panels



The Troax Medium Panel UX 450 is a stronger variant based on a welded tube construction of 30×20 mm. The mesh consists of pressure-welded wire gauges of 3×3.75 mm, with the mesh equivalent to 50×50 mm.

#### PANELS

Troax Medium is based on the UX 450 mesh panel, an alternative that suits the need for a higher level of protection. Troax UX 450 is a stable mesh partition that protects against break-ins. The panels are built from welded 30×20 mm tubing. The mesh is made from press-welded 3×3.75 mm wire. The mesh size is 50×50 mm, which makes it almost impossible to get a hand through it. The smooth assembly makes UX 450 adaptable to almost every type of premises. This storage system suits both narrow and wide spaces, regardless of ceiling height. It is compatible with Troax UR 350 and Troax UX 550.

#### DOORS

The UX 450 door is included in the Troax Medium system to be used in combination with UX 450 mesh panels. The door is excellent for >>

use in spaces that have a relatively strong exterior protection. The padlock door has a specially designed cover to protect the padlock, minimising the risk of break-ins. The leaf has a frame made from 30×20 mm steel tubing and two specially designed cross tubes, making it stable and secure. These doors are thresholdless, which makes them easy for people with disabilities to use, and are delivered ready for installation.

### PROTECTION FROM VIEW

UR SP is a solid partition panel that provides exceptional protection against break-ins. This is mainly used as a front wall in spaces that already have a reasonable level of exterior protection. The sheet metal panels make it impossible for anyone on the outside to view what is inside the storage. This system also includes solid doors as an alternative to mesh doors. The door is equipped with a latch for a padlock. UR SP can easily be combined with our other types of storage partitions made of mesh.

### ACCESSORIES

Troax accessories make it possible to adapt mesh partitions to the majority of premises, even those with sloping floors or ceilings. For example, the unique floor foot allows step-free adjustments to be made in case of an uneven floor. Self-tapping screws, combined with a variety of different mountings make installation simple. Our Snapper mounting quickly attaches panels to one another. Special sections are available to fill any gaps that arise between the panels and the walls and ceiling. The range of accessories also includes different shelving systems with brackets for versatile placement, as well as a special system for storing skis.



### ASSA Cylinder lock

Strong lock casing for ASSA cylinder.



### EURO Cylinder lock

Strong lock casing for EURO cylinder.



### Padlock with cover

The Medium door is supplied with a strong strike plate protected by welded casing.



### Securing plate for padlocks

UR SP metal door with a padlock plate



A close-up, low-angle shot of a steel mesh panel. The perspective is from below, looking up at the grid of metal wires. The lighting is warm and directional, coming from the right, which creates a strong highlight along one of the horizontal wires and casts soft shadows across the rest of the mesh. The overall color palette is a range of browns and oranges, from deep, dark tones in the shadows to bright, almost white highlights on the illuminated wire.

“Steel mesh panels form  
the basis of all our systems.”



# Troax Safe.

Troax Safe is our most secure system of storage partitions. It is based on the UX550 mesh panel, which complies with the requirements of the Swedish Theft Prevention Association's break-in protection standard for storage fittings. Troax Safe is suitable for spaces that are particularly vulnerable to attempted break-ins, such as storage spaces in apartment buildings, as well as bicycle storage areas. Just like our other systems, Troax Safe provides a light and airy storage environment where it is easy to detect and extinguish a fire.

**Strong, secure.**

**Modular.**

**Quality construction.**

## PANELS

Security was the main focus in the development of UX 550, our most advanced and secure mesh partition. The partition has special sections in order to minimise the risk of potential break-ins. The system has been tested and approved in accordance with SSF 1990-06-30/B. UX 550 is primarily used in storage spaces in apartment buildings, cellars and attics that require an extra high level of security. Using the Troax mesh partition system, you can create compatible storage spaces pretty much anywhere. For example, Troax Safe can be complemented with partitions from the UX 450 and UR 350 series.

## DOORS

The UX 550 door is designed to be used in combination with the UX 550 mesh panels in the Troax Safe system. The system has been tested and approved by the Swedish Theft Prevention Association (SSF) and the door can be used in spaces that require an extra high level of security. The leaf has a frame made from 30×20 mm steel tubing and two specially designed cross tubes, making it stable and secure. The door is also equipped with a specially designed cover that provides extra protection to the padlock. The mesh size is the same as the partition panels, 50×50 mm. The doors are easy to use by people with physical disabilities, and are delivered ready for mounting.

## ACCESSORIES

Troax Safe is part of a system of specially adapted assembly mountings, making it possible to install secure storage spaces in almost every type of premise: narrow or wide, low or high ceilings, as well as sloping floors. The system has been tested and approved by the Swedish Theft Prevention Association (SSF) and is used in areas which are particularly exposed to break-in attempts. The range of accessories for Troax Safe also includes shelving systems with brackets for versatile placement, as well as a special system for storing skis.



### Panel (H×W) mm:

Panel UX 550	2,200×200
Panel UX 550	2,200×300
Panel UX 550	2,200×700
Panel UX 550	2,200×800
Panel UX 550	2,200×1,000
Panel UX 550	2,200×1,200
Panel UX 550	2,200×1,500

### Door Troax Safe UX 550 (H×W) mm:

Door UX 550, P 900	2,200×900
Opening size	1,860×860

### Door Troax Safe UX 550 (H×W) mm:

Door UX 550, P 900	2,200×900
Opening size	1,860×820
Door UX 550, EC 900	2,200×900
Opening size	2,000×810
Door UX 550, AC 900	2,200×900
Opening size	2,000×810

### Component information UX 550

Frame	30×20×1.5 mm
Wire	5.0×5.0 mm
Mesh	50×50 mm
Surface treatment	Powder coating, Grey RAL 7037

Also available in galvanised finish and RAL colours.

"Our products are  
developed with your  
safety in focus."



## TROAX SAFE UX 550

Our well-renowned Troax Safe UX550 is the market's strongest alternative, offering a system that includes smart accessories for the most theft-prone environments. The uniquely designed sections for panel joints provide the system with superior strength. The door is available with a padlock or a cylinder lock.

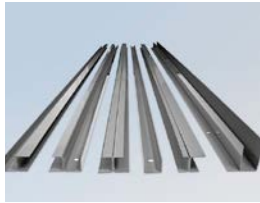

### Profile system

To secure the installation, there are several strong profile options.



### Secure installation

Using the profile system, all joints are secured to prevent break-ins.



### Certification

The system is certified by the Swedish Theft Prevention Association (SSF).

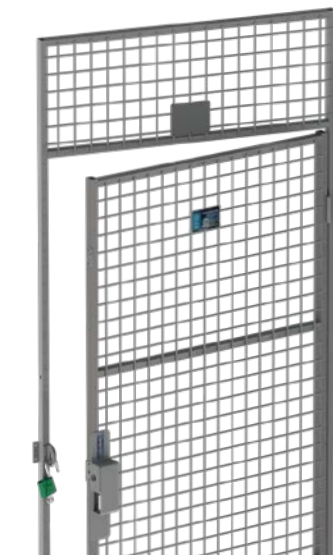
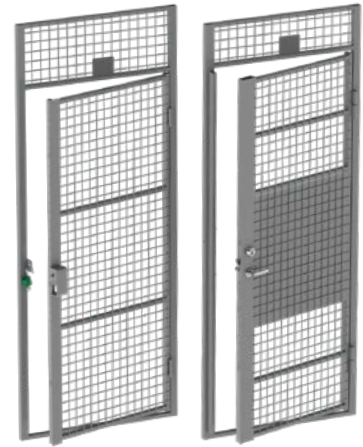

## TROAX SAFE UX 500

Our new certified system is based on a new door model designated Troax Safe UX 500. The front wall is comprised of our strongest panel, UX 550. The installation method and panel joints are more like those used for our Troax Medium, utilising our unique floor support that enables a threshold-less door opening and a more cost-effective installation. The door is available with a padlock.



### Floor support

The unique floor support design enables height adjustment for uneven floors.



### Screws and fittings

Our screws and fittings enable rapid and secure installation.



### Certification

The system is certified by the Swedish Theft Prevention Association (SSF).



### Panel

The systems are based on UX 550, but can be combined with UX 450, UR 350.

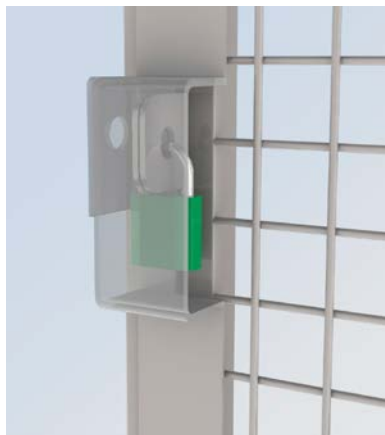

### Padlock with cover

Door Troax Safe UX 500 and UX 550 use the same sturdy casing to protect the padlock.



### Troax Safe UX 500

Our latest SBSC-certified product, a more cost-effective solution for demanding environments.



# Troax Self storage.

Troax is the complete self storage system supplier, with flexible solutions for any self storage concept. Our roller doors and sheet metal partitions have been developed specifically for self storage facilities, and it is as simple to install as it is easy to use. Also, it requires minimal maintenance.

**Attractive.**

**Versatile.**

**Maintenance-Free.**

At Troax we specialize in sales and installation of modern third-generation Self-Storage facilities and storage solutions. Our unique system with high gloss white hall systems in combination with nice coloured doors giving your customers a good first impression, not only today but for many years ahead.

#### **LET'S DRAW THE ROLLER WALL.**

No matter if you are planning for your first project or your thirtieth, you can always contact us with your inquiries. We will gladly examine your property, and provide a blueprint with full pricing – without requiring the purchase. The proposal, as well as the blueprint, will include an estimate of how much it would cost to convert your building into a self-storage, including how much the return on your investment would be.

Our sales and design team knows how to use every available space to achieve maximum lettable area (Uby), and we have full understanding how important it is to get the right mix of unit sizes.

#### **AVAILABLE ALL OVER EUROPE.**

- The roller door and the partition sections, as is the roller door, are made of corrugated sheet metal.
- White gloss paint is the standard – but other colours are available, of course.





#### Hallway wall system

Max Height (mm)	Thickness (mm)
3,000	0.4

#### Unit partition wall system

Max Height (mm)	Thickness (mm)
3,000	0.4

#### Dimensions rollup door

Max Height (mm)	Max Width (mm)
3,000	3,000

#### Dimensions swing door

Max Height (mm)	Max Width (mm)
2,250	1,000

Latches available for both door types are cylinder lock and padlock.  
Standard option latch in stainless steel.





### UNIQUE PANEL DESIGN

We sell panels both with and without assembly. At the self-assembly, we provide introduction and rapid training of your local assembly team.



#### Rollup door

The best choice for an easy operable and low maintenance roll-up door.



#### Wall panels

The wall system provides an economical and attractive divider.

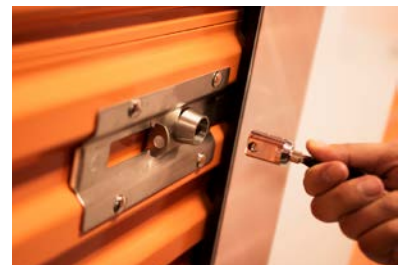

#### Keeping it safe

Every storage room has its own lock, to which only the storage holder has the key.

# Show your true colours.

Colour has always played an important role in the human evolution. We see the environment through its colours, and the brain processes what it perceives. All of our mesh panels and systems are available in any colour you want, so you can make a statement in your world.

---

**Smart Accessories.** Troax' popular storage systems provide tenants with the high level of protection and security they expect. Once you've found the door that best fulfils your needs, we're also able to offer you a wide range of smart and unique accessories. Contact us for more information. [www.troax.com](http://www.troax.com)



#### Door closer

Ensure that the door always closes behind you for greater peace of mind.



#### Number plate

An optional extra that attaches to the door leaf if it is of a custom height.



#### Quiet closing

Rubber noise-damping doorstop to minimise noise when closing.



#### Store room numbering

We can supply optional numbering for all doors.



#### Noise-damping ceiling mount

A rubber mount that minimises noise propagation up into the building.

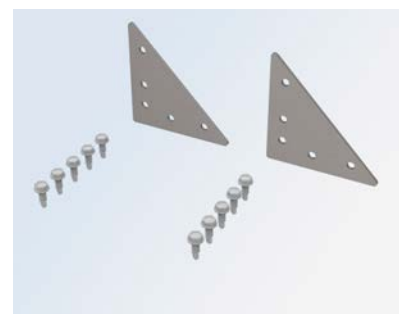

#### Door reinforcement kit

Enables you to cut a door leaf to size in place with retained frame strength.



# Local & global presence.

Troax is represented in more than 30 countries and has 24 sales companies of its own. We aim to strengthen our position worldwide and expand our business on each continent.

At Troax, we meet your needs through local sales offices, backed up by daily deliveries from the world's largest warehouse for mesh panels, Troax in Hillerstorp, Sweden.

## **STRONG MARKET SEGMENTS**

Our systems are marketed in three segments: Machine guarding, Warehouse partitioning and Property protection.

### **1. MACHINE GUARDING**

Today's modern industry, with its advanced processes, places

significant demands on safety. In particular, there is a great need for controlled access for authorised personnel. Our mesh panels are based on a carefully developed modular system that also includes special adaptations.

### **2. WAREHOUSE PARTITIONING**

Troax can meet all requirements for storage and security. We are suppliers to all types of industry – from traditional manufacturers that require large-scale flows and volumes through their factories, to facilities with high-

bay storage and retail storage. We can meet all your requirements and we offer complete solutions.

### **3. PROPERTY PROTECTION**

Whether a question of new development or renovation of an existing installation, we are convinced that you will find our products easy to work with. Your unique needs and our creativity have contributed to our constant product development, giving rise to our motto: "Secure storage must be simple."



## Making your world **safe.**

There are dangers for people, property, and processes in the world.  
But there is no need to worry. Because we always strive to make it safe.  
We are there, at your workplace, at your friends' and families' workplaces, at your home,  
and at your friends' and families' homes. You may not always see us or think about us,  
but we are always there, protecting and making your world safe, wherever you are.

**Read more at [troax.com](http://troax.com)**

